



BER-MAR ELECTRIC MOTORS
BLOWERS
AND DRIVES

PM SERIES

PERMANENT MAGNET MOTORS
STAND ALONE MOTORS (SPM RANGE)
INVERTED INTEGRATED (GPM RANGE)



PM MOTORS MEET CUSTOMER NEEDS

Mandatory energy efficiency regulations for energy using products (EuPs) and energy related products (ErPs) have been enforced by the European Union.

Ber-Mar as a professional electric motors manufacturer who cares about environment and energy saving, one of our most important goals is to help our partners to reduce total life operation costs, increase profitability and make production more environmentally friendly.

To meet customer and EU needs, Ber-Mar have developed high efficiency AC motors meeting both IE2 and IE3 levels. Permanent Magnet (PM) electric motors have been developed to meet the IE4 level.

Ber-Mar's current range of permanent magnet IE4 motors, named PM, are based upon Interior Permanent Magnet (IPM) design, the product will be launched under SPM name.

Ber-Mar's PM motors use rare earth elements as Neodymium in the construction of the magnet elements.

In order to develop the PM Motor, Ber-Mar used a combination of product designs inspired by the brushless servo motor's electrical design and the AC induction motor's mechanical design.

With higher efficiencies than standard AC induction motors they also enhance the power/weight ratio, thereby allowing for significant size and weight reductions of up to 50%.

The Ber-Mar's PM Motor range is primarily targeted applications in pumps, fans, compressors, and blowers, where there is an emphasis on reducing the operating cost or weight, and size of the motors.

Ber-Mar also offer flexibility in terms of design, customising the active and mechanical parts of the motor to suit specific customer requirements.

A inverter integrated motor (GPM) version of the product is also available, which includes an integrated drive control system.

RANGE OF PRODUCTS

Stand-alone motor (SPM range), Inverter integrated (GPM range)
Sensorless control or with speed transducer
Standard ventilation (IC 411) or forced ventilation (IC 416)
DC Brake option

GENERAL SPECIFICATION

Power output: 0.25 to 6,6 kW (Range will be extended during 2018) -380-480 V, 50/60 Hz
Torque: 3 to 15 Nm
Compact range in IEC frames: 63-71-80-90
Speed range up to 4500 rpm

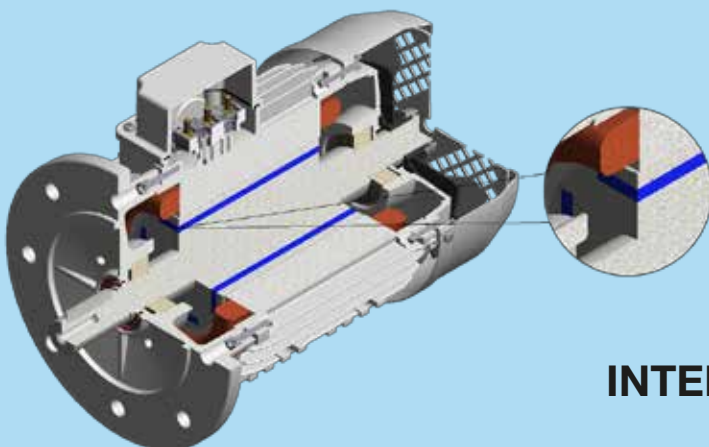

IPM DESIGN

INTERIOR PERMANENT MAGNETS

DRIVE SPECIFICATIONS

MAIN SUPPLY

Supply frequency	50 / 60Hz
Supply voltage	3 x 380/480V ± 10%

OUTPUT RATINGS

Output rated current	100% continuously @ 40°C
Overload capacity	150% for 60 sec 200% for 4 sec

DIGITAL INPUT

Programmable digital input	5
Voltage level	0-24VDC (user selectable npn/pnp)

ANALOG INPUT

Programmable analog voltage input	1
Voltage level	0:10VDC
Programmable analog current input	1
Current range	0:20mA

BUS COMMUNICATION

RS485 or CANbus	for cascade mode
RS485	serial communication
CANbus	CANopen
EtherCAT	Profibus
Profinet	Ethernet IP

RELAY OUTPUT

Programmable relay output

PROGRAMMING

Keypad	Yes
PC	Yes

CONTROL SPECIFICATION

Frequency range	up to 400Hz
Control method	Sensorless AC Vector Control
Max PWM frequency	10KHz

EXTERNALS

Enclosure	IP55
Max operating ambient temperature (Full load)	0 - 40°C
Storage ambient temperature	÷ 25°C - 60°C

COMPLIANCE WITH STANDARDS

EN 61800-3:2004	Adjustable speed electrical power drive systems. EMC requirements
IEC 61800-5-1	Adjustable speed electrical drive systems - part 5-1: safety requirements - electrical, thermal and energy
EN 60204-1	Safety of machinery - electrical EMC equipment of machines - part 1: general rules

REDUCTION OF WEIGHT & DIMENSIONS

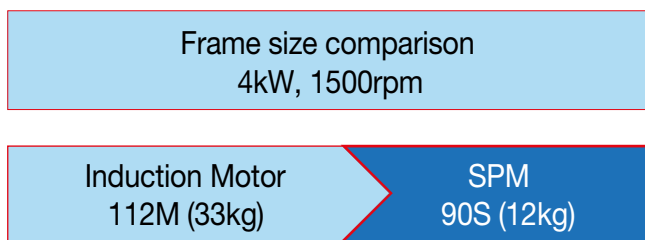

EFFICIENCY STANDARD

Efficiencies are harmonized to the International Standard IEC 60034-30-2:2016 that extends the efficiency levels to Super Premium Efficiency IE4

Output kW	IE4 REFERENCE LIMIT			
	Rated speed within 600 to 900 /min	Rated speed within 901 to 1200 /min	Rated speed within 1201 to 1800 /min	Rated speed within 1801 to 6000 /min
0.12	62.3	64.9	69.8	66.5
0.18	67.2	70.1	74.7	70.8
0.2	68.4	71.4	75.8	71.9
0.25	70.8	74.1	77.9	74.3
0.37	74.3	78	81.1	78.1
0.4	74.9	78.7	81.7	78.9
0.55	77	80.9	83.9	81.5
0.75	78.4	82.7	85.7	83.5
1.1	80.8	84.5	87.2	85.2
1.5	82.6	85.9	88.2	86.5
2.2	84.5	87.4	89.5	88
3	85.9	88.6	90.4	89.1
4	87.1	89.5	91.1	90
5.5	88.3	90.5	91.9	90.9
7.5	89.3	91.3	92.6	91.7
11	90.4	92.3	93.3	92.6
15	91.2	92.9	93.9	93.3
18.5	91.7	93.4	94.2	93.7
22	92.1	93.7	94.5	94
30	92.7	94.2	94.9	94.5
37	93.1	94.5	95.2	94.8
45	93.4	94.8	95.4	95
55	93.7	95.1	95.7	95.3
75	94.2	95.4	96	95.6
90	94.4	95.6	96.1	95.8
110	94.7	95.8	96.3	96
132	94.9	96	96.4	96.2

ECONOMIC ADVANTAGES OF USING SPM MOTORS

Working efficiently

High efficiency motors offer the following advantages:

- Reduced consumption and electricity costs;
- Greater efficiency in all load conditions, particularly with reduced loads, with smaller constant losses;
- Greater efficiency at all speeds, particularly those below the nominal speed.

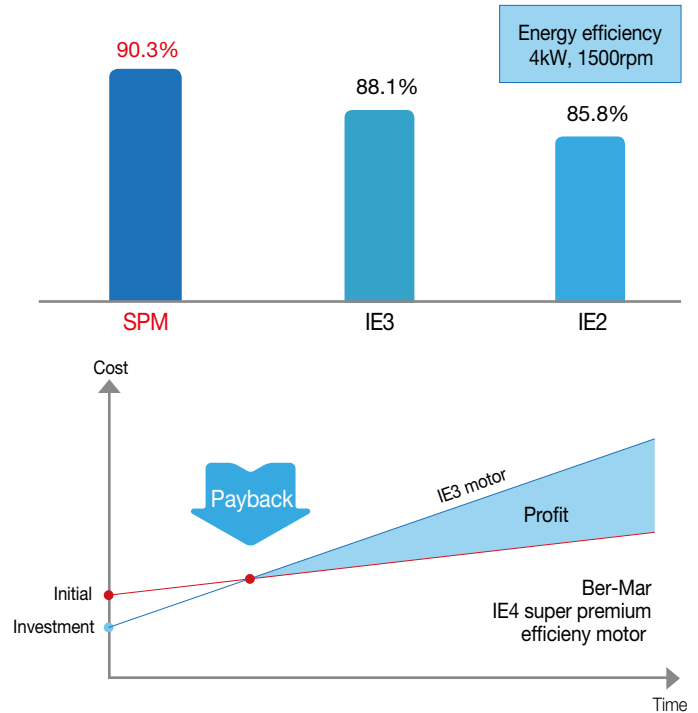

CALCULATION OF ENERGY AND COSTS SAVINGS

Induction motor IE1 or IE2 or IE3

Energy used in a year [kWh/year]:

$$E_{\text{INDUCTION}} = \frac{P_{\text{NOM}} \times \frac{L\%}{100}}{\frac{\eta\%_{\text{INDUCTION}}}{100}} \times H$$

Annual energy cost [Eur/year]:

$$CA_{\text{INDUCTION}} = E_{\text{INDUCTION}} \times C$$

Savings

Energy saved in a year [kWh/year]:

$$E = E_{\text{INDUCTION}} - E_{\text{SPM}}$$

Annual savings [Eur/year]:

$$RA = CA_{\text{INDUCTION}} - CA_{\text{SPM}}$$

Payback time for the additional motor costs [Months]:

$$TR = \frac{(Pr_{\text{SPM}} - Pr_{\text{INDUCTION}})}{RA} \times 12$$

SPM motor

Energy used in a year [kWh/year]:

$$E_{\text{SPM}} = \frac{P_{\text{NOM}} \times \frac{L\%}{100}}{\frac{\eta\%_{\text{SPM}}}{100}} \times H$$

Annual energy cost [Eur/year]:

$$CA_{\text{SPM}} = E_{\text{SPM}} \times C$$

where:

- P_{nom} [kW]: Rated motor output
- $L\%$: Coefficient (%) of use of the rated motor output
- $\eta\%_{\text{INDUCTION}}$: Performance (%) of the induction motor (IE1/IE2/IE3)
- $\eta\%_{\text{SPM}}$: Performance (%) of the SPM brushless motor
- H [h/year]: Annual use of the motor
- C [Eur/kWh]: Cost per kWh
- $Pr_{\text{INDUCTION}}$ [Euro]: Price of the induction motor (IE1/IE2/IE3)
- Pr_{SPM} [Eur]: Price of the SPM brushless motor

POSSIBLE MOTOR CONFIGURATIONS

SPM motors are supplied as standard in the following configuration:

- Cooling system IC411 (self-ventilated)
- Without service brake
- Sensorless speed control

Other configurations are shown in the following table, and are supplied on request:

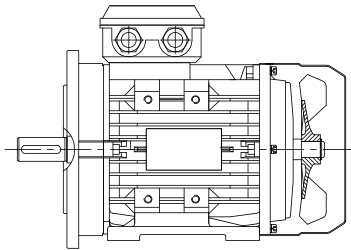

Standard version
Cooling method
IC411 self-ventilated

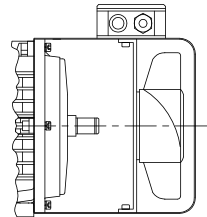

Special version
Cooling method
IC416 forced ventilation

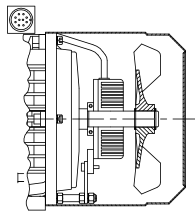

Standard version
Cooling method IC411 self-ventilated
Speed transducer option

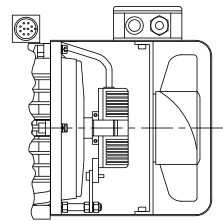

Special version
Cooling method IC416 forced ventilated
Speed transducer option

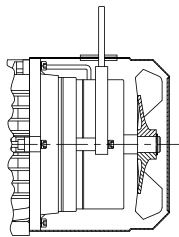

Standard version
Cooling method IC411 self-ventilated
DC brake option

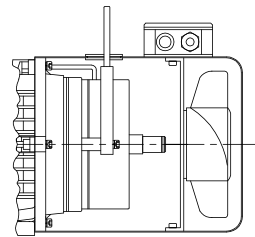

Special version
Cooling method IC416 forced ventilation
DC brake option

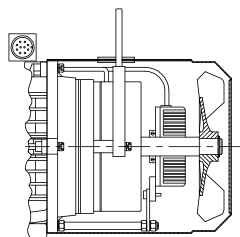

Standard version
Cooling method IC411 self-ventilated
Speed transducer and DC brake option

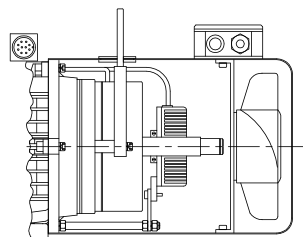

Special version
Cooling method IC416 forced ventilation
Speed transducer and DC brake option

HOW TO ORDER A MOTOR

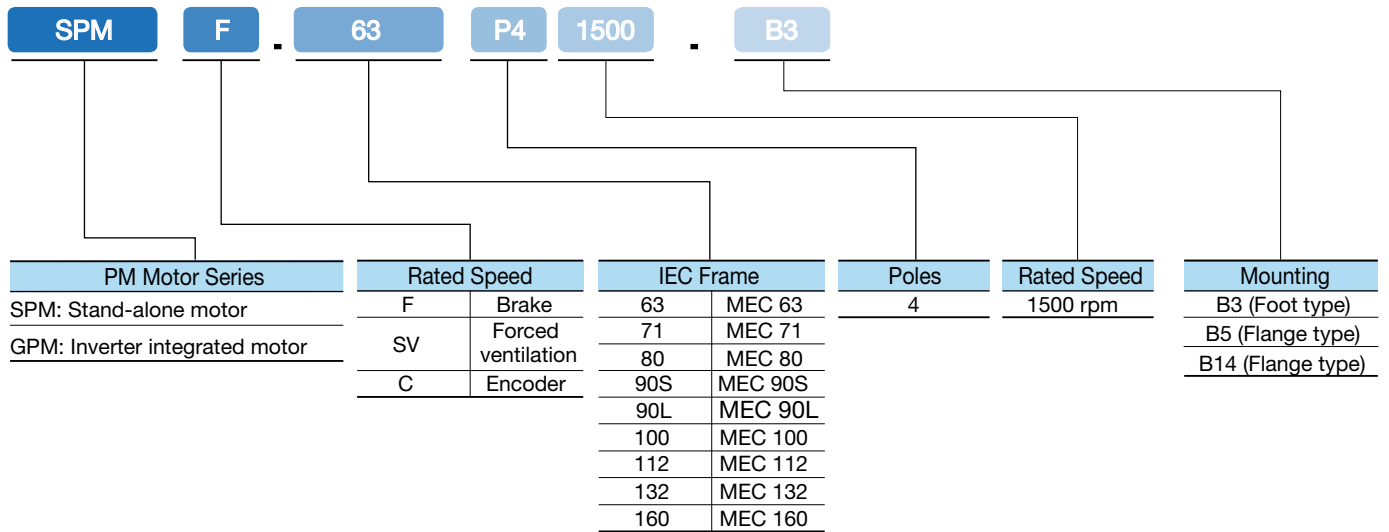

CONSTRUCTION FORMS AND ASSEMBLY POSITIONS

Available construction forms: IM B3, IM B5, IM B14 and combined forms IM B35 (B3/B5) and IM B34 (B3/B14).

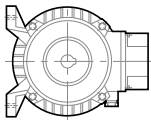
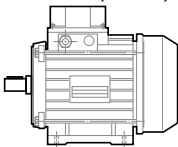
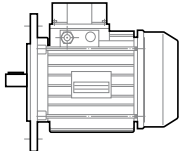
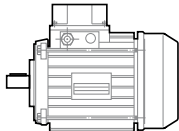
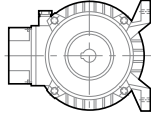
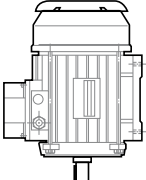
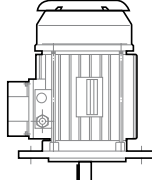
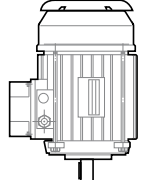
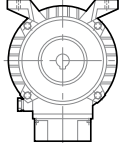
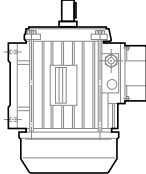
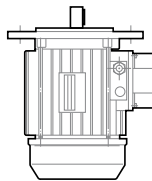
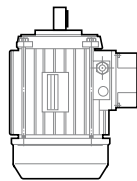
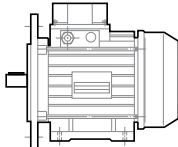
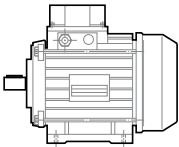
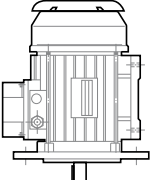
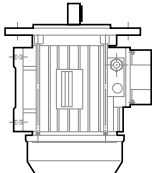
Motors B3 with fixing feet		Motors with B5 flange fixing through holes	Motors with B14 flange fixing with threaded holes
IM 1051 (IM B6) 	IM 1001 (IM B3) 	IM 3001 (IM B5) 	IM 3601 (IM B14) 
IM 1061 (IM B7) 	IM 1011 (IM V5) 	IM 3011 (IM V1) 	IM 3611 (IM V18) 
IM 1071 (IM B8) 	IM 1031 (IM V6) 	IM 3031 (IM V3) 	IM 3631 (IM V19) 
IM 2001 (IM B35)  B3/B5	IM 2101 (IM B34)  B3/B14	IM 2011 (IM V15)  V1/V5	IM 2031 (IM V36)  V3/V6

SPM 63

SPM.632P41500

MOTOR MODEL			SPM.632P41500					
INVERTER			I.LSLV0004S100-4EOFNS			I.LSLV0008S100-4EOFNS		
INVERTER POWER			kW 0,40			kW 0,80		
CONNECTION			Y	Y	Y	Δ	Δ	Δ
DESCRIPTION	SYMBOL	UNIT OF MEASURE						
Rated power	P	[kW]	0,25	0,33	0,40	0,8	0,8	
Power supply	V	[V]			400			
Rated frequency	f	[HZ]	25	33,3	50	100	150	
Base frequency	V/f	[HZ]		50			87	
Rated speed	RPM	[RPM]	750	1000	1500	3000	4500	
Inverter output voltage		[V]	250	313	350	345	397	
Voltage constant ±5%	Ke	[Vrms/krpm]	333,3	313,0	233,3	115,0	90,2	
Torque constant ±5%	Kt	[Nm/Arms]	5,25	5,25	3,54	1,82	1,29	
Rated torque	Tn	[Nm]	3,20	3,20	2,55	2,55	2,00	
Rated current	In	[Arms]	0,61	0,61	0,72	1,40	1,55	
Efficiency	η	[%]	79,3	80,0	83,4	85,8	86,0	
Power factor	Cosφ		0,879	0,896	0,895	0,896	0,899	
Maximum torque	Tm	[Nm]	5,9	5,4	3,8	3,2	1,8	
Starting torque	Ts	[Nm]	3,80	3,80	3,80	4,00	3,90	
Maximum torque current	Im	[Arms]	1,35	1,35	1,41	1,91	2,89	
Starting torque current	Is	[Arms]	1,42	1,44	1,53	2,39	3,03	
Phase-phase resistance @ 20°C	Rff	[Ω]		50,30		50,30		
Inverter resistance	Ri	[Ω]		20,07		35,81		
Phase-phase inductance	Lff	[mH]		194		194		
LD inductance	Ld	[mH]		105,04		105,4		
LQ inductance	Lq	[mH]		197,1		64,1		
Inductance flow	Li	[mH]		0,597		0,597		
Ambient temperature	θa	[°C]				-20 ÷ +40		
Protection class		IP				55		
Cooling system		IC				411 (OPTIONAL IC 416)		
Insulation class						F		
Overtemperature class						B		
Standard thermal protection						PTC 130°C		
Rotor inertia	J	[kgm ²]				0,000266		
Motor weight		[kg]				4,11		

SPM 63

SPM.633P41500

MOTOR MODEL			SPM.633P41500					
INVERTER			I.LSLV0004S100-4EOFNS			I.LSLV0008S100-4EOFNS		
INVERTER POWER			kW 0,40			kW 0,80		
CONNECTION			Y	Y	Y	Δ	Δ	Δ
DESCRIPTION	SYMBOL	UNIT OF MEASURE						
Rated power	P	[kW]	0,25	0,33	0,55	1,00	1,10	
Power supply	V	[V]			400			
Rated frequency	f	[HZ]	25	33,3	50	100	150	
Base frequency	V/f	[HZ]		50			87	
Rated speed	RPM	[RPM]	750	1000	1500	3000	4500	
Inverter output voltage		[V]	228	288	351	350	388	
Voltage constant ±5%	Ke	[Vrms/krpm]	304,0	288,0	234,0	116,7	88,2	
Torque constant ±5%	Kt	[Nm/Arms]	5,93	4,93	3,13	1,52	1,13	
Rated torque	Tn	[Nm]	3,50	3,50	3,50	3,20	3,00	
Rated current	In	[Arms]	0,59	0,71	1,12	2,11	2,65	
Efficiency	η	[%]	81,0	81,2	84,1	85,8	86,2	
Power factor	Cosφ		0,477	0,579	0,566	0,615	0,788	
Maximum torque	Tm	[Nm]	7,55	7,51	7,53	5,57	3,12	
Starting torque	Ts	[Nm]	7,50	7,20	7,10	5,80	3,06	
Maximum torque current	Im	[Arms]	2,50	2,40	2,50	3,20	3,90	
Starting torque current	Is	[Arms]	2,70	2,80	2,90	3,60	4,20	
Phase-phase resistance @ 20°C	Rff	[Ω]		30,64		30,64		
Inverter resistance	Ri	[Ω]		11,37		21,01		
Phase-phase inductance	Lff	[mH]		134		134		
LD inductance	Ld	[mH]		63,20		117		
LQ inductance	Lq	[mH]		197,1		64,1		
Inductance flow	Li	[mH]		0,597		0,597		
Ambient temperature	θa	[°C]				-20 ÷ +40		
Protection class		IP				55		
Cooling system		IC				411 (OPTIONAL IC 416)		
Insulation class						F		
Overtemperature class						B		
Standard thermal protection						PTC 130°C		
Rotor inertia	J	[kgm ²]				0,000342		
Motor weight		[kg]				4,71		

SPM 71

SPM.711P41500

MOTOR MODEL			SPM.711P41500					
INVERTER			I.LSLV0008S100-4EOFNS			I.LSLV0015S100-4EOFNS		
INVERTER POWER			kW 0,80			kW 1,50		
CONNECTION			Y	Y	Y	Δ	Δ	Δ
DESCRIPTION	SYMBOL	UNIT OF MEASURE						
Rated power	P	[kW]	0,45	0,60	0,85	1,00	1,10	
Power supply	V	[V]	400					
Rated frequency	f	[HZ]	25	33,3	50	100	150	
Base frequency	V/f	[HZ]	50			87		
Rated speed	RPM	[RPM]	750	1000	1500	3000	4500	
Inverter output voltage		[V]	343	307	343	350	388	
Voltage constant ±5%	Ke	[Vrms/krpm]	457,3	307,0	228,7	116,7	88,2	
Torque constant ±5%	Kt	[Nm/Arms]	5,00	4,58	3,93	1,52	1,13	
Rated torque	Tn	[Nm]	5,50	5,50	5,50	3,20	3,00	
Rated current	In	[Arms]	1,10	1,20	1,40	2,11	2,65	
Efficiency	η	[%]	81,0	89,0	93,0	85,8	86,2	
Power factor	Cosφ		0,554	0,602	0,605	0,615	0,788	
Maximum torque	Tm	[Nm]	14,0	14,0	14,0	5,57	3,12	
Starting torque	Ts	[Nm]	10,9	11,3	11,5	5,80	3,06	
Maximum torque current	Im	[Arms]	3,51	3,73	3,77	3,20	3,90	
Starting torque current	Is	[Arms]	3,81	3,88	4,09	3,60	4,20	
Phase-phase resistance @ 20°C	Rff	[Ω]	30,64			30,64		
Inverter resistance	Ri	[Ω]	11,37			21,01		
Phase-phase inductance	Lff	[mH]	134			134		
LD inductance	Ld	[mH]	63,20			117		
LQ inductance	Lq	[mH]	197,1			64,1		
Inductance flow	Li	[mH]	0,597			0,597		
Ambient temperature	θa	[°C]	-20 ÷ +40					
Protection class		IP	55					
Cooling system		IC	411 (OPTIONAL IC 416)					
Insulation class			F					
Overtemperature class			B					
Standard thermal protection			PTC 130°C					
Rotor inertia	J	[kgm ²]	0,000695					
Motor weight		[kg]	7,33					

SPM 71

SPM.712P41500

MOTOR MODEL			SPM.712P41500					
INVERTER			I.LSLV0008S100-4EOFNS			I.LSLV0022S100-4EOFNS		
INVERTER POWER			kW 0,80			kW 2,20		
CONNECTION			Y	Y	Y	Δ	Δ	Δ
DESCRIPTION	SYMBOL	UNIT OF MEASURE						
Rated power	P	[kW]	0,55	0,75	1,10	2,20	2,20	
Power supply	V	[V]			400			
Rated frequency	f	[HZ]	25	33,3	50	100	150	
Base frequency	V/f	[HZ]		50			87	
Rated speed	RPM	[RPM]	750	1000	1500	3000	4500	
Inverter output voltage		[V]	346	309	332	350	388	
Voltage constant ±5%	Ke	[Vrms/krpm]	457	307	229	117	88	
Torque constant ±5%	Kt	[Nm/Arms]	4,51	4,37	3,68	1,79	1,05	
Rated torque	Tn	[Nm]	7,0	7,0	7,0	7,0	4,7	
Rated current	In	[Arms]	1,55	1,61	1,89	3,91	4,48	
Efficiency	η	[%]	83,1	85,2	87,4	88,8	89,1	
Power factor	Cosφ		0,879	0,896	0,895	0,896	0,899	
Maximum torque	Tm	[Nm]	11,0	11,0	11,0	11,0	11,0	
Starting torque	Ts	[Nm]	10,0	10,0	10,0	10,0	10,0	
Maximum torque current	Im	[Arms]	2,95	3,11	3,15	4,55	5,32	
Starting torque current	Is	[Arms]	3,19	3,28	3,45	4,77	5,45	
Phase-phase resistance @ 20°C	Rff	[Ω]		11,16		6,49		
Inverter resistance	Ri	[Ω]		12,01		4,20		
Phase-phase inductance	Lff	[mH]		123		123		
LD inductance	Ld	[mH]		112,3		37,1		
LQ inductance	Lq	[mH]		209,8		65,9		
Inductance flow	Li	[mH]		0,174		0,147		
Ambient temperature	θa	[°C]				-20 ÷ +40		
Protection class		IP				55		
Cooling system		IC				411 (OPTIONAL IC 416)		
Insulation class						F		
Overtemperature class						B		
Standard thermal protection						PTC 130°C		
Rotor inertia	J	[kgm ²]				0,00164		
Motor weight		[kg]				7,33		

SPM 80

SPM.801P41500

MOTOR MODEL			SPM.801P41500					
INVERTER			I.LSLV0008S100-4EOFNS		I.LSLV0015S100-4EOFNS		I.LSLV0022S100-4EOFNS	
INVERTER POWER			kW 0,80		kW 1,50		kW 2,20	
CONNECTION			Y	Y	Y	Δ	Δ	Δ
DESCRIPTION	SYMBOL	UNIT OF MEASURE						
Rated power	P	[kW]	0,55	0,80	1,10	2,20	2,20	
Power supply	V	[V]	400					
Rated frequency	f	[HZ]	25	33,3	50	100	150	
Base frequency	V/f	[HZ]	50				87	
Rated speed	RPM	[RPM]	750	1000	1500	3000	4500	
Inverter output voltage		[V]	244	320	344	350	355	
Voltage constant ±5%	Ke	[Vrms/krpm]	325,3	320,0	229,3	116,7	80,7	
Torque constant ±5%	Kt	[Nm/Arms]	4,66	4,52	3,73	2,01	1,18	
Rated torque	Tn	[Nm]	7,45	8,13	7,45	7,45	4,97	
Rated current	In	[Arms]	1,60	1,80	2,00	3,70	4,20	
Efficiency	η	[%]	85,1	85,5	88,8	91,1	92,4	
Power factor	Cosφ		0,534	0,644	0,651	0,712	0,662	
Maximum torque	Tm	[Nm]	13,8	15,0	13,8	13,8	9,20	
Starting torque	Ts	[Nm]	14,5	15,8	14,5	14,5	9,60	
Maximum torque current	Im	[Arms]	6,25	6,31	4,79	7,90	8,38	
Starting torque current	Is	[Arms]	6,88	6,94	5,27	8,69	9,22	
Phase-phase resistance @ 20°C	Rff	[Ω]	13,10		13,10			
Inverter resistance	Ri	[Ω]	11,96		4,86			
Phase-phase inductance	Lff	[mH]	179,7		179,7			
LD inductance	Ld	[mH]	138,6		50,86			
LQ inductance	Lq	[mH]	234,6		80,1			
Inductance flow	Li	[mH]	0,597		0,597			
Ambient temperature	θa	[°C]	-20 ÷ +40					
Protection class		IP	55					
Cooling system		IC	411 (OPTIONAL IC 416)					
Insulation class			F					
Overtemperature class			B					
Standard thermal protection			PTC 130°C					
Rotor inertia	J	[kgm ²]	0,00158					
Motor weight		[kg]	10,20					

SPM 80

SPM.802P41500

MOTOR MODEL			SPM.802P41500					
INVERTER			I.LSLV0015S100-4EOFNS			I.LSLV0022S100-4EOFNS		
INVERTER POWER			kW 1,50			kW 2,20		
CONNECTION			Y	Y	Y	Δ	Δ	Δ
DESCRIPTION	SYMBOL	UNIT OF MEASURE						
Rated power	P	[kW]	0,75	1,0	1,50	3,0	3,0	
Power supply	V	[V]	400					
Rated frequency	f	[HZ]	25	33,3	50	100	150	
Base frequency	V/f	[HZ]	50			87		
Rated speed	RPM	[RPM]	750	1000	1500	3000	4500	
Inverter output voltage		[V]	233	300	337	352	345	
Voltage constant ±5%	Ke	[Vrms/krpm]	310,7	300,0	224,7	117,3	78,4	
Torque constant ±5%	Kt	[Nm/Arms]	4,13	4,13	3,39	1,86	1,12	
Rated torque	Tn	[Nm]	9,50	9,50	9,50	9,50	6,50	
Rated current	In	[Arms]	2,30	2,30	2,80	5,11	5,81	
Efficiency	η	[%]	85,1	86,4	87,6	90,3	91,5	
Power factor	Cosφ		0,554	0,712	0,667	0,748	0,688	
Maximum torque	Tm	[Nm]	22,0	21,0	23,0	20,0	13,5	
Starting torque	Ts	[Nm]	20,1	20,9	20,4	20,2	14,3	
Maximum torque current	Im	[Arms]	5,80	6,90	9,10	9,10	9,70	
Starting torque current	Is	[Arms]	6,38	7,59	10,01	10,01	10,67	
Phase-phase resistance @ 20°C	Rff	[Ω]	8,45			8,45		
Inverter resistance	Ri	[Ω]	9,90			3,18		
Phase-phase inductance	Lff	[mH]	69,3			69,3		
LD inductance	Ld	[mH]	104,6			34,47		
LQ inductance	Lq	[mH]	161			60,99		
Inductance flow	Li	[mH]	0,147			0,147		
Ambient temperature	θa	[°C]	-20 ÷ +40					
Protection class		IP	55					
Cooling system		IC	411 (OPTIONAL IC 416)					
Insulation class			F					
Overtemperature class			B					
Standard thermal protection			PTC 130°C					
Rotor inertia	J	[kgm ²]	0,002511					
Motor weight		[kg]	10,5					

SPM 90

SPM.90SP41500

MOTOR MODEL			SPM.90SP41500						
INVERTER			I.LSLV0015S100-4EOFNS		I.LSLV0040S100-4EOFNS		I.LSLV0055S100-4EOFNS		
INVERTER POWER			kW 1,50		kW 4,0		kW 5,5		
CONNECTION			Y	Y	Y	Δ	Δ	Δ	
DESCRIPTION	SYMBOL	UNIT OF MEASURE							
Rated power	P	[kW]	1,10	1,50	2,20	4,0	5,5		
Power supply	V	[V]	400						
Rated frequency	f	[HZ]	25	33,3	50	100	150		
Base frequency	V/f	[HZ]	50			87			
Rated speed	RPM	[RPM]	750	1000	1500	3000	4500		
Inverter output voltage		[V]	218	264	358	346	350		
Voltage constant ±5%	Ke	[Vrms/krpm]	290,7	264,0	238,7	115,3	79,5		
Torque constant ±5%	Kt	[Nm/Arms]	4,14	4,23	3,73	1,86	1,21		
Rated torque	Tn	[Nm]	14,9	15,3	14,9	13,6	12,4		
Rated current	In	[Arms]	3,60	3,60	4,0	7,30	10,3		
Efficiency	η	[%]	86,2	89,8	91,8	91,5	92,4		
Power factor	Cosφ		0,505	0,644	0,707	0,687	0,662		
Maximum torque	Tm	[Nm]	30,0	30,0	28,0	25,0	18,0		
Starting torque	Ts	[Nm]	27,0	29,0	28,0	24,0	24,0		
Maximum torque current	Im	[Arms]	7,70	8,20	7,50	10,5	11,4		
Starting torque current	Is	[Arms]	7,70	8,30	8,20	13,3	14,6		
Phase-phase resistance @ 20°C	Rff	[Ω]	5,33			5,33			
Inverter resistance	Ri	[Ω]	5,92			2,10			
Phase-phase inductance	Lff	[mH]	50,6			50,5			
LD inductance	Ld	[mH]	65,5			23,7			
LQ inductance	Lq	[mH]	61,0			40,0			
Inductance flow	Li	[mH]	0,597			0,597			
Ambient temperature	θa	[°C]	-20 ÷ +40						
Protection class		IP	55						
Cooling system		IC	411 (OPTIONAL IC 416)						
Insulation class			F						
Overtemperature class			B						
Standard thermal protection			PTC 130°C						
Rotor inertia	J	[kgm ²]	0,002956						
Motor weight		[kg]	12,8						

SPM 90

SPM.90LP41500

MOTOR MODEL			SPM.90LP41500					
INVERTER			I.LSLV0015S100-4EOFNS		I.LSLV0040S100-4EOFNS		I.LSLV0055S100-4EOFNS	
INVERTER POWER			kW 1,50		kW 4,0		kW 5,5	
CONNECTION			Y	Y	Y	Δ	Δ	Δ
DESCRIPTION	SYMBOL	UNIT OF MEASURE						
Rated power	P	[kW]	1,35	1,90	2,75	5,5	5,5	
Power supply	V	[V]	400					
Rated frequency	f	[HZ]	25	33,3	50	100	150	
Base frequency	V/f	[HZ]	50			87		
Rated speed	RPM	[RPM]	750	1000	1500	3000	4500	
Inverter output voltage		[V]	240	260	250	340	345	
Voltage constant ±5%	Ke	[Vrms/krpm]	320,0	260,0	166,7	113,3	78,4	
Torque constant ±5%	Kt	[Nm/Arms]	4,48	4,42	3,73	2,15	1,36	
Rated torque	Tn	[Nm]	18,3	18,8	18,6	18,6	12,4	
Rated current	In	[Arms]	4,08	4,25	5,00	8,65	9,10	
Efficiency	η	[%]	87,4	87,6	90,5	91,6	91,6	
Power factor	Cosf		0,534	0,698	0,667	0,735	0,662	
Maximum torque	Tm	[Nm]	33,8	34,8	34,5	34,5	23,0	
Starting torque	Ts	[Nm]	35,5	36,5	36,2	36,2	24,1	
Maximum torque current	Im	[Arms]	14,1	14,2	14,6	24,1	25,5	
Starting torque current	Is	[Arms]	15,5	15,6	16,1	26,5	28,1	
Phase-phase resistance @ 20°C	Rff	[Ω]	3,91			3,91		
Inverter resistance	Ri	[Ω]	4,36			1,77		
Phase-phase inductance	Lff	[mH]	62,2			62,2		
LD inductance	Ld	[mH]	48,9			14,8		
LQ inductance	Lq	[mH]	100,2			29,4		
Inductance flow	Li	[mH]	0,147			0,597		
Ambient temperature	θa	[°C]	-20 ÷ +40					
Protection class		IP	55					
Cooling system		IC	411 (OPTIONAL IC 416)					
Insulation class			F					
Overtemperature class			B					
Standard thermal protection			PTC 130°C					
Rotor inertia	J	[kgm ²]	0,003562					
Motor weight		[kg]	15,45					

SPM 90

SPM.90L1P41500

MOTOR MODEL			SPM.90L1P41500						
INVERTER			I.LSLV0022S100-4EOFNS		I.LSLV0040S100-4EOFNS		I.LSLV0055S100-4EOFNS		
INVERTER POWER			kW 1,50		kW 4,0		kW 5,5		
CONNECTION			Y	Y	Y	Δ	Δ	Δ	
DESCRIPTION	SYMBOL	UNIT OF MEASURE							
Rated power	P	[kW]	1,65	2,20	3,30	6,6	6,6		
Power supply	V	[V]	400						
Rated frequency	f	[HZ]	25	33,3	50	100	150		
Base frequency	V/f	[HZ]	50			87			
Rated speed	RPM	[RPM]	750	1000	1500	3000	4500		
Inverter output voltage		[V]	223	288	348	340	345		
Voltage constant ±5%	Ke	[Vrms/krpm]	297,3	288,0	232,0	113,3	78,4		
Torque constant ±5%	Kt	[Nm/Arms]	4,30	4,30	3,73	1,86	1,21		
Rated torque	Tn	[Nm]	22,4	22,4	22,4	22,4	14,9		
Rated current	In	[Arms]	5,20	5,20	6,0	12,0	12,0		
Efficiency	η	[%]	86,8	87,6	90,2	91,4	91,8		
Power factor	Cosφ		0,654	0,698	0,667	0,735	0,662		
Maximum torque	Tm	[Nm]	36,9	37,8	39,1	36,9	24,6		
Starting torque	Ts	[Nm]	38,7	39,7	41,1	38,7	25,8		
Maximum torque current	Im	[Arms]	11,2	11,3	11,5	17,8	19,8		
Starting torque current	Is	[Arms]	12,3	12,5	12,6	19,5	21,8		
Phase-phase resistance @ 20°C	Rff	[Ω]	2,58			2,58			
Inverter resistance	Ri	[Ω]	2,92			1,02			
Phase-phase inductance	Lff	[mH]	24,8			24,8			
LD inductance	Ld	[mH]	44,2			13,3			
LQ inductance	Lq	[mH]	63,4			18,6			
Inductance flow	Li	[mH]	0,147			0,597			
Ambient temperature	θa	[°C]	-20 ÷ +40						
Protection class		IP	55						
Cooling system		IC	411 (OPTIONAL IC 416)						
Insulation class			F						
Overtemperature class			B						
Standard thermal protection			PTC 130°C						
Rotor inertia	J	[kgm ²]	0,003725						
Motor weight		[kg]	16,65						



BER·MAR **ELECTRIC MOTORS
BLOWERS
AND DRIVES**

Via C. Bassi 28/a | 40015 S. Vincenzo di Galliera (BO) | Italy
Tel +39 051.812120 | Fax +39 051.812074 | www.bermar.it | info@bermar.it